

# Clarke®

## weld



## MIG/MMA/TIG INVERTER WELDER

### MODEL NO: MIG 120 MULTI

PART NO: 6015601

## OPERATION & MAINTENANCE INSTRUCTIONS



ORIGINAL INSTRUCTIONS

GC0722

---

## INTRODUCTION

---

Thank you for purchasing this CLARKE Welder. Before attempting to operate the machine it is essential that you read this manual thoroughly and carefully follow all instructions given. In doing so you will ensure the safety of yourself and that of others around you, and you can also look forward to the welder giving you long and satisfactory service.

When unpacking, any damage or deficiency should be reported to your CLARKE dealer immediately.

---

## SPECIFICATIONS

---

	<b>MIG120 Multi</b>
Unpacked Weight (kg)	6.8
Dimensions (l x w x h) (mm)	305 x 155 x 233
Power Supply	230V~ 50Hz
Connecting plugs	BS1363 (13A)
Max Input Power	3.9 KW
Max Input Current	17.3A
No Load Voltage	63V
Output Welding Current	MIG 20A/15V -120A/20v MMA 20A/18.8V - 100A/24V TIG 20A/10.8V - 100A/14V
IP Rating	IP21S
Insulation Grade	Class 1 - Grade H
Suitable Electrode size	1.6-3.2mm
Welding Wire size	0.6mm, 0.8mm, 0.9mm & 1.0mm (flux cored) 0.6mm, 0.8mm (solid)
Welding Capacity (Mild Steel)	1-5 mm (MIG) 1.5-4.5 (MMA)

**NOTE:** The details and specifications contained herein, are correct at the time of going to print. However, CLARKE International reserve the right to change specifications at any time without prior notice.

---

## PRINCIPLES OF THE MACHINE

---

The MIG120 Multi is an inverter type welding machine, suitable to carry out Gas and No Gas CO<sub>2</sub> welding, MMA, TIG and MIG (MAG -USA welding). The welder is mainly used for CO<sub>2</sub> gas protected welding which has the advantages of high energy efficiency, strong arc penetration and small welding deformation.

Weldable materials include low carbon steel, low alloy steel, high strength steel, stainless steel and aluminium alloy. Methods include full position spot welding, butt welding, fillet welding and lap welding. The stable welding process can be obtained by using pure CO<sub>2</sub>, CO<sub>2</sub>+Ar, CO<sub>2</sub>+ O<sub>2</sub> and other protective gases. The torch is suitable for wire diameters of 0.6-1.0mm.

Manual Metal Arc (MMA) welding uses a coated consumable electrode (stick) to lay the weld, therefore an additional welding torch kit is not used. The arc melts the core of the electrode to produce drops of molten metal (weld pool) that cool to create the welded joint. Because of the versatility and simplicity of MMA welding, it requires less skill and is used primarily to weld iron and steel (including stainless steel, but nickel and copper can also be welded using this method.

MIG (Metal Inert Gas) welding allows you to fuse together two similar metals without altering the properties of the metal.

A consumable wire electrode is continuously fed through the welding torch fitted with a concentric gas nozzle, the wire is connected to a high voltage supply which creates an electric arc between the electrode (the wire) and the workpiece. The arc is used to create the required heat to turn the metal into a molten state. The wire is used as both the electrode and as a filler.

The gas is used to prevent oxidation and to shield the arc and the weld from atmospheric contamination. The choice of gas is dependent upon the material being welded. This machine is designed to be used for both metal ARC (MMA) and TIG welding.

(TIG welding leads are not supplied with the machine. These are however, readily available from your CLARKE dealer (Part number 6012233).

A wide selection of accessories and consumables are available from your CLARKE dealer (see page 36)

## SUITABILITY OF DIFFERENT METHODS

MMA/Arc Welding	Carbon Steel, Low Alloy Steel, Stainless Steel, Cast Iron.
MIG Welding	Carbon Steel, Mild Steel, Stainless Steel
TIG Welding	Carbon Steel, Low Alloy Steel, Stainless Steel, Cast Iron, Titanium, Copper + Brass.

Metal Being Welded	Suitable Gas	Part number
Mild Steel	Carbon Dioxide (CO <sub>2</sub> )	6000642
Stainless Steel	Argon	6000663
Aluminium		
Thin Sheet Metal/Mild Steel	Carbon Dioxide (CO <sub>2</sub> )/Argon Mix	6000662

When using the welder in a gasless configuration the shielding gas is created from the flux within the welding wire.

When using the welder outside you may need to erect a wind break to make sure the shielding gas is not blown away, thereby leaving a poor quality weld.

---

## ENVIRONMENTAL RECYCLING POLICY

---



Through purchase of this product, the customer is taking on the obligation to deal with the WEEE in accordance with the WEEE regulations in relation to the treatment, recycling & recovery and environmentally sound disposal of the WEEE.

In effect, this means that this product must not be disposed of with general household waste. It must be disposed of according to the laws governing Waste Electrical and Electronic Equipment (WEEE) at a recognised disposal facility.

If disposing of this product or any damaged components, do not dispose of with general waste. This product contains valuable raw materials. Metal products should be taken to your local civic amenity site for recycling of metal products.

---

# SAFETY PRECAUTIONS FOR ALL TYPES OF WELDING

---



**WARNING: AS WITH ALL MACHINERY, THERE ARE CERTAIN HAZARDS INVOLVED WITH THEIR OPERATION AND USE. EXERCISING RESPECT AND CAUTION WILL CONSIDERABLY LESSEN THE RISK OF PERSONAL INJURY. HOWEVER, IF NORMAL SAFETY PRECAUTIONS ARE OVERLOOKED, OR IGNORED, PERSONAL INJURY TO THE OPERATOR MAY RESULT.**

---

FAILURE TO FOLLOW THESE RULES MAY RESULT IN SERIOUS PERSONAL INJURY.

## GENERAL PRECAUTIONS

### BURN PREVENTION

Wear protective clothing - gauntlet gloves designed for use in welding, apron, and protective shoes. Button shirt collar and pocket flaps and wear cuffsless trousers to avoid entry of sparks and slag. Wear helmet with safety goggles or glasses with side shields underneath, appropriate filter lenses or plates (protected by clear glass). This is a **MUST** for welding (and chipping) to protect the eyes from radiant energy and spatter. Replace cover glass when broken, pitted, or spattered. Avoid oily or greasy clothing. A spark may ignite them. Hot metal should never be handled without gloves. First aid facilities and a qualified first aid person should be available unless medical facilities are close by for immediate treatment of flash burns of the eyes and skin burns. A hard hat should be worn when others work overhead. Flammable hair preparations should not be used by persons intending to weld or cut.

**NOTE:** ALL protective wear incl. masks & head shields **MUST** comply with PPE Regulation (EU) 2016/425.

### TOXIC FUME PREVENTION

Severe discomfort, illness or death can result from fumes, vapours, heat, or oxygen enrichment or depletion that welding (or cutting) may produce. Prevent them with adequate ventilation. **NEVER** ventilate with oxygen. Lead-, cadmium-, zinc-, mercury- and beryllium-, bearing materials, when welded (or cut) may produce harmful concentrations of toxic fumes. Adequate local exhaust ventilation must be used, or each person in the area as well as the operator must wear an air- supplied respirator. For beryllium, both must be used. Metals coated with or containing materials that emit toxic fumes should not be heated unless coating is removed from the work surface, the area is well ventilated, or the operator wears an air-supplied respirator. Work in a confined space only while it is being force ventilated and, if necessary, while wearing an air-supplied respirator. Vapours from chlorinated solvents can be decomposed by the heat of the arc (or flame) to form PHOSGENE, a highly toxic gas, and other lung and eye irritating by-products. The ultraviolet (radiant) energy of the arc can also decompose trichloroethylene and perchloroethylene vapours to form phosgene. **DO NOT WELD** where solvent

vapours can be drawn into the welding atmosphere or where the radiant energy can penetrate to atmospheres containing even minute amounts of trichloroethylene or perchloroethylene.

## **FIRE AND EXPLOSION PREVENTION**

Causes of fire and explosion are:

1. Combustibles reached by the arc, flying sparks, hot slag or heated material;
2. Short circuits.

BE AWARE that flying sparks or falling slag can pass through cracks, along pipes, through windows or doors, and through wall or floor openings, out of sight of the goggled operator.

To prevent fires and explosion: keep equipment clean and operable, free of oil, grease, and (in electrical parts) of metallic particles that can cause short circuits. If combustibles are in the area, **DO NOT** weld. Move the work if practicable, to an area free of combustibles.

Avoid working in paint spray rooms, dip tanks, storage areas, ventilators. If the work cannot be moved, move combustibles away from sparks and heat; or protect against ignition with suitable fire-resistant covers or shields.

Walls, ceilings, and floor near work should be protected by heat resistant covers or shields. Fire watcher must be standing by with suitable fire extinguishing equipment during and for some time after welding or cutting if:

1. Appreciable combustibles (including building construction) are within 10m.
2. Appreciable combustibles are further than 10m, but can be ignited by sparks.
3. Openings (concealed or visible) in floors or walls can expose combustibles to sparks.
4. Combustibles adjacent to walls, ceilings, roofs or metal partitions can be ignited by radiant or conducted heat.

After work, check that area is free of sparks, glowing embers and flames. An empty container that held combustibles or that can produce flammable or toxic vapours when heated, must never be welded on or cut, unless the container has first been cleaned. This includes a thorough steam or caustic cleaning (or a solvent or water washing, depending on the combustible's solubility) followed by purging and inerting with nitrogen or carbon dioxide, and using protective equipment.

Water filling just below the working level may substitute for inerting.

A container with unknown contents should be cleaned (see paragraph above). DO NOT depend on sense of smell or sight to determine if it is safe to

weld or cut. Hollow castings or containers must be vented before welding as they can explode.

In explosive atmospheres, **NEVER** weld or cut where the air may contain flammable dust, gas, or liquid vapours.

**DO NOT** overload arc welding equipment. It may overheat cables and cause a fire. Loose cable connections may overheat or flash and cause a fire. **NEVER** strike an arc on a cylinder or other pressure vessel. It creates a brittle area that can cause a violent rupture or lead to such a rupture later under rough handling.

---

## **ELECTRIC ARC WELDING**

---

Comply with precautions in above and this section. Arc welding, properly done, is a safe process but a careless operator invites trouble. The equipment carries high currents at significant voltages. The arc is very bright and hot. Sparks fly, fumes rise, ultraviolet and infrared energy radiates and work pieces are hot. The wise operator avoids unnecessary risks and protects himself and others from accidents.

### **BURN PROTECTION**

The welding arc is intense and visibly bright. It's radiation can damage eyes, penetrate lightweight clothing, reflect from light coloured surfaces and burn the skin and eyes. Skin burns resemble acute sunburn, those from gas - shielded arcs are more severe and painful.

#### **PROTECTIVE CLOTHING (PPE) MUST BE WORN**

Wear long sleeved clothing (particularly for gas shielded arc) in addition to gloves, apron and strong shoes. As necessary, use additional protective clothing such as leather jacket or sleeves, flameproof apron, and fire-resistant leggings. Avoid outer garments of untreated cotton. Bare skin protection: Wear dark substantial clothing, Button collars closed to protect the chest and neck and button any pockets to prevent entry of sparks.

#### **EYE AND HEAD PROTECTION**

Protect eyes from exposure to arc. **NEVER** look at an electric arc without protection. Welding helmet or shield containing an appropriate filter plate (Please refer to the section 'Welding Shield on page 12). Place over face before striking arc. Protect filter plate with a clear cover plate. Cracked or broken helmet or shield should NOT be worn; radiation can pass through to cause burns.

Cracked, broken, or loose filter plates must be replaced IMMEDIATELY. Replace clear cover plate when broken, pitted, or spattered. WE SUGGEST you wear flash goggles with side shields under the helmet, to give some protection to the eyes should the helmet not be lowered over the face before

an arc is struck. Looking at an arc momentarily with unprotected eyes (particularly high intensity gas-shielded arc) can cause a retinal burn that may leave a permanent dark area in the field of vision. Before welding whilst wearing contact lenses, seek advice from your optician.

### **PROTECTION OF NEARBY PERSONNEL**

For production welding, a separate, well vented room or enclosed bay is best. In open areas, surround the operation with low reflective, non-combustible screens or panels. Allow for free air circulation, particularly at floor level. Provide face shields for all persons who will be looking directly at the weld. Others working in the area should wear flash goggles. Before starting to weld, make sure that screen or bay doors are closed.

### **SHOCK PREVENTION**

Exposed live conductors or other bare metal in the welding circuit, or in unearthed, electrically-LIVE equipment can fatally shock a person whose body becomes a conductor. **DO NOT STAND, SIT, LIE, LEAN ON, OR TOUCH** a wet surface when welding without suitable protection.

### **PROTECTION FOR WEARERS OF ELECTRONIC LIFE SUPPORT DEVICES (PACEMAKERS)**

Magnetic fields from high currents can affect pacemaker operation. Persons wearing pacemakers should consult with their doctor before going near arc welding or spot welding operations.

### **PROTECTION AGAINST SHOCK**

Keep your body and clothing dry. **NEVER** work in damp area without adequate insulation against electric shock. Stay on a dry duckboard or rubber mat when dampness or sweat can not be avoided. Sweat, sea water, or moisture between body and an electrically LIVE part - or earthed metal - reduces the body surface electrical resistance, enabling dangerous and possibly lethal currents to flow through the body.

### **EARTHING THE EQUIPMENT**

When arc welding equipment is earthed according to the National Electrical Code and the workpiece is earthed, a voltage may exist between the electrode and any conducting object.

Examples of conducting objects include, but are not limited to, buildings, electrical tools, work benches, welding power source cases, workpieces, etc. **NEVER** touch the electrode and any metal object unless the welding power source is off. When installing, connect the frames of each unit such as welding power source, control, work table, and water circulator to the building earth. Conductors must be adequate to carry earth currents safely. Equipment made electrically live by stray current may shock, possibly fatally. **DO NOT EARTH** to electrical conduit or to a pipe carrying ANY gas or a flammable liquid such as oil or fuel.



## **CABLES**

Frequently inspect cables for wear, cracks and damage. IMMEDIATELY REPLACE those with excessively worn or damaged insulation to avoid possibly lethal shock from bared cable. Cables with damaged areas may be taped to give resistance equivalent to original cable. Keep cable dry, free of oil and grease and protected from hot metal and sparks.

## **TERMINALS AND OTHER EXPOSED PARTS**

Terminals and other exposed parts of electrical units should have insulating covers secured before operation.

## **SAFETY DEVICES**

Safety devices such as interlocks and circuit breakers should not be disconnected or shunted out. Before installation, inspection, or service of equipment, shut off all power and remove line fuses (or lock or red-tag switches) to prevent accidental turning ON of power. **DO NOT** open power circuit or change polarity while welding. If, in an emergency, it must be disconnected, guard against shock burns, or flash from switch arcing. Always shut OFF and disconnect all power to equipment. A power disconnect switch must be available near the welding power source.

---

## **PREPARATION OF THE WORKING AREA**

---

The working area must be sufficiently spacious, not humid, and well-ventilated as to avoid any fumes which develop from the welding process and from incidental material adhering to the pieces to be welded (oils, paints, tars...) which may cause danger to the operator.

Avoid welding tanks which may contain flammable residuals.



**WARNING: ELECTRIC SHOCK CAN BE FATAL. A PERSON QUALIFIED IN FIRST AID SHOULD ALWAYS BE PRESENT IN THE WORKING AREA. IF PERSON IS UNCONSCIOUS AND ELECTRIC SHOCK IS SUSPECTED, DO NOT TOUCH THE PERSON IF HE OR SHE IS IN CONTACT WITH THE WELDER OR CABLES. DISCONNECT THE WELDER FROM THE POWER SOURCE AND THEN USE FIRST AID. DRY WOOD OR OTHER INSULATING MATERIAL CAN BE USED TO MOVE CABLES, IF NECESSARY, AWAY FROM THE PERSON.**

---

---

## ADDITIONAL PRECAUTIONS FOR MMA WELDING

---

1. **ALWAYS** ensure that there is full free air circulating around the outer casing of the machine and that the louvres are unobstructed.
2. A welding arc can seriously damage your eyes. Both operator and spectators must **ALWAYS** use a proper welding face shield or helmet with suitable filter lenses. Proper gloves and working clothes should be worn at all times.
3. **ALWAYS** remove all flammable materials from the welding area.
4. **NEVER** remove any of the panels unless the machine is disconnected from the supply and never use the machine with any of the panels removed.
5. **NEVER** use or store in a damp environment. **DO NOT EXPOSE TO RAIN.**
6. **NEVER** attempt any electrical or mechanical repair unless you are a qualified technician. If you have a problem with the machine contact your local CLARKE dealer.
7. **ALWAYS** keep a fire extinguisher handy (Dry Powder, CO<sub>2</sub> or BCF, NOT Water).
8. **NEVER** continue to weld, if, at any time, you feel even the smallest electric shock. Stop welding **IMMEDIATELY** and **DO NOT** attempt to use the machine until the fault is diagnosed and corrected.
9. **NEVER** allow the earth cable or torch to become wrapped around the operator or any person in the vicinity.

A comprehensive range of CLARKE safety equipment for use when welding is available from your local dealer. See page 37.















Consideration should be given to shielding the supply cable of permanently installed welding equipment, in metallic conduit or equivalent. Shielding should be electrically continuous throughout its length.

The shielding should be connected to the welding power source so that good electrical contact is maintained between the conduit and the welding power source enclosure.

The welding equipment should be routinely maintained according to the manufacturer's recommendations (see page 33). All access and service doors and covers should be closed and properly fastened when the welding equipment is in operation. The welding equipment should not be modified in any way except for those changes and adjustments covered in the manufacturer's instructions. In particular, the spark gaps of arc striking and stabilizing devices should be adjusted and maintained according to the manufacturers recommendations.

# SAFETY SYMBOLS

The following symbols may be displayed on the machine or its packaging.

	Read this instruction booklet carefully before use.		Do not expose to rain.
	Wear welding mask		Recycle unwanted materials under WEEE Directive
	Wear protective gloves		General Hazard
	Wear a dust mask		Warning:- Magnetic field created (
	Caution:- Hot surface		Danger! Harmful fumes
	Risk of Electric Shock		Do not weld near flammable or combustible materials
	Do not weld near flammable or combustible materials		Danger:- Arc Rays
	May interfere with pacemakers		

## ELECTRICAL CONNECTION



**WARNING! READ THESE ELECTRICAL SAFETY INSTRUCTIONS THOROUGHLY BEFORE CONNECTING THE PRODUCT TO THE MAINS SUPPLY.**

Before switching the product on, make sure that the voltage of your electricity supply is the same as that indicated on the rating plate. This product is designed to operate on 230VAC 50Hz. Connecting it to any other power source may cause damage.

This product may be fitted with a non-rewireable plug. If it is necessary to change the fuse in the plug, the fuse cover must be refitted. If the fuse cover becomes lost or damaged, the plug must not be used until a suitable replacement is obtained.

If the plug has to be changed because it is not suitable for your socket, or due to damage, it should be cut off and a replacement fitted, following the wiring instructions shown below. The old plug must be disposed of safely, as insertion into a mains socket could cause an electrical hazard.

If the colours of the wires in the power cable of this product do not correspond with the markings on the terminals of your plug, proceed as follows.

- The **Blue** wire must be connected to the terminal marked **N** or coloured **Black**.
- The **Brown** wire must be connected to the terminal marked **L** or coloured **Red**.
- The **Yellow and Green** wire must be connected to the terminal marked **E** or  or coloured Green.

**Plug must be BS1363/A approved.**

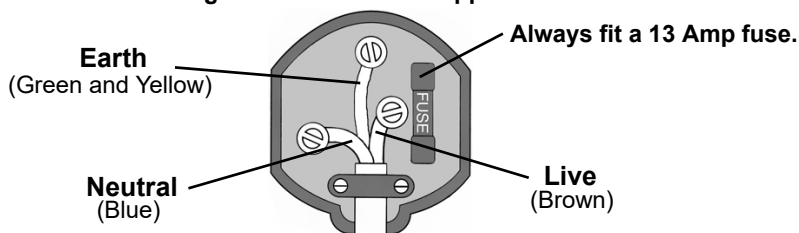

**Ensure that the outer sheath of the cable is firmly held by the clamp**

We strongly recommend that this machine is connected to the mains supply via a Residual Current Device (RCD). If in any doubt, consult a qualified electrician. DO NOT attempt any repairs yourself.

## OVERVIEW & INVENTORY

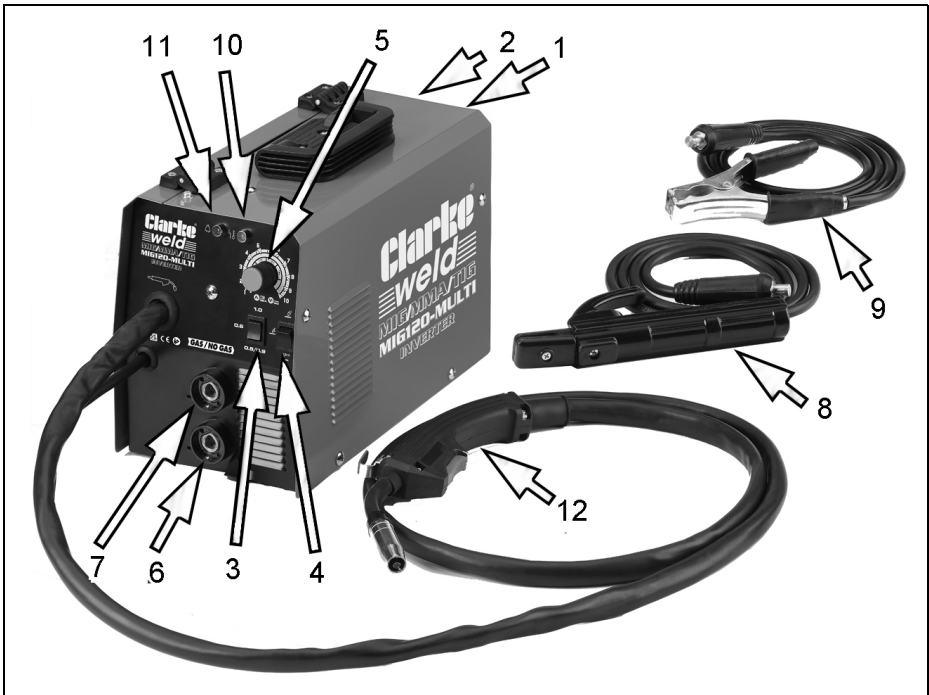

### The MIG120 Multi- welder is fitted with:

1. On/off Switch (at rear)
2. Gas cylinder connecting port (at rear)
3. Wire thickness selector switch
4. MIG/MMA/LIFT TIG function selector switch
5. Current selector knob
6. Positive terminal
7. Negative terminal
8. 1 x Torch Cable/Electrode Holder
9. 1 x Earth Cable/Clamp
10. Overheating LED
11. Power-On LED
12. 1 x MIG welding torch with hose (0.8mm tip)

### Loose items supplied include the following:

13. 1 x Hammer/brush
14. 1 x Face shield
15. 1x Spool of 0.6mm mild steel welding wire
16. 1x Spool of 0.9 mild steel welding wire
17. 1 x 0.6mm welding torch tip
18. 1 x 0.8mm welding torch tip (fitted)
19. 1 x 0.9mm welding torch tip
20. 1 x 0.6/0.8mm wire roller (fitted)
21. 1 x 0.9/1mm wire roller
22. 1 x torch wrench (for changing tips)
23. 1 x 520mm Gas hose
24. 1 x Gas bottle holder (2 pieces)

## THE CONTROL FUNCTIONS

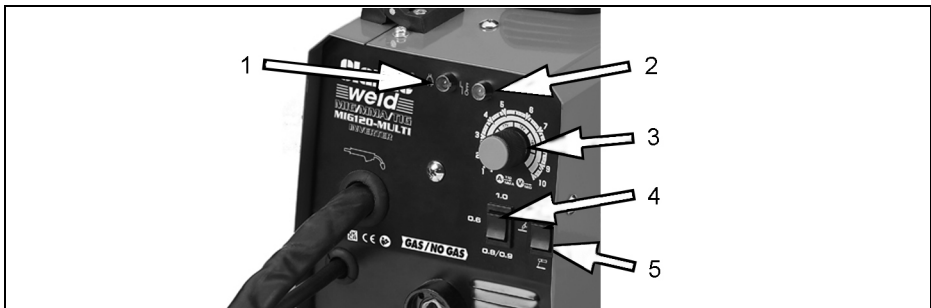

- 1. Power LED.** When the power is switched on at the rear of the machine the switch will be illuminated, as will the green 'Power On' LED.
- 2. Thermal overload LED.** If the duty cycle is exceeded as a result of welding for too long with a high current, the overload light will illuminate and the welder will turn off. When the welder has cooled down (approx. 5 to 10 minutes), the power will be restored and welding can recommence.
- 3. Wire speed /current control knob.** A higher current requires a higher wire speed. Wire speed should be set based upon the table on page 28.
- 4. Wire thickness selector switch.** For use with MIG/Flux welding in one of three positions (0.6, 0.8/0.9, 1.0).
- 5. MIG/MMA/LIFT TIG function selector switch** for welding mode selection.

## ASSEMBLING THE WELDING SHIELD

1. The welding shield shown is supplied flat for shipping. Fold the sides of the shield around and clip to the top panel.

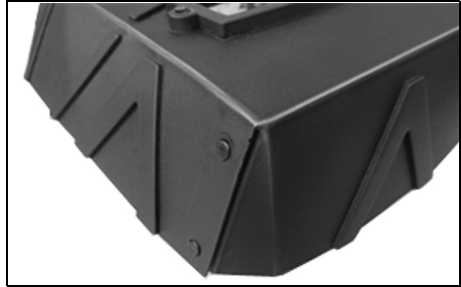

2. Insert both the glass lens panels into the recess inside the shield.

- The clear glass must be fitted first to face the outside.

3. Insert the two plastic screws and use the plastic wingnuts to clamp the glass panels to the shield.

- The clear glass panel should be replaced when it becomes badly pitted.

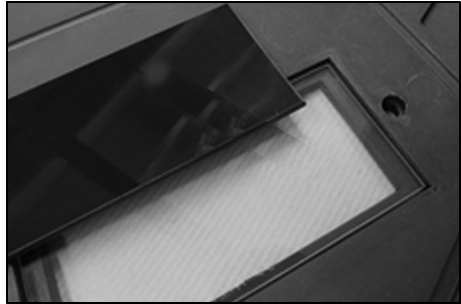

4. When replacing the glass panels, only use parts supplied by CLARKE International. The dark panel is a certified, optical glass and should not be exchanged for any other type.

5. Secure the handle in position using the plastic nuts provided.

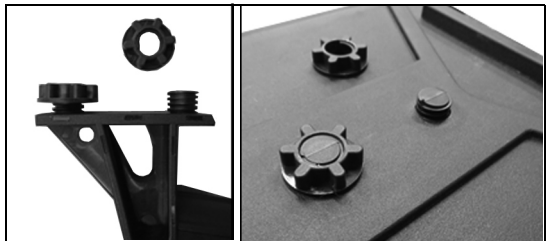

- The handle will be mounted on the inside of the shield.



---

## PREPARATION FOR USE

---

### FITTING THE GAS BOTTLE HOLDER

---



**WARNING: NEVER OPERATE THIS MACHINE WITH THE SIDE PANELS PARTIALLY OPENED OR REMOVED.**

---

***IMPORTANT: Ensure that the welder is not connected to the mains supply before opening.***

1. Open the side panel by pushing the latch down and allowing the side panel to drop down.
2. Remove any loose items that have been transported inside.
3. Place the lower bottle bracket into position and secure in place using the 2 screws provided.
4. Secure the top clip in place using the screw provided.



5. Fit the gas cylinder to the rear of the machine. Install the pressure relief valve to the gas cylinder and ensure it is tight to prevent leakage.



## MOUNTING THE WELDING WIRE SPOOL



**WARNING: MAKE SURE THAT THE WELDER IS NOT CONNECTED TO THE MAINS SUPPLY.**

Select the appropriate wire diameter according to the welding process. After the wire diameter is selected, check that the wire diameter matches the size of the wire feeding wheel and the welding torch components.

Spools of welding wire are available from your CLARKE dealer.

1. Open the side panel by pushing the latches down and allowing the side panel to open.
2. Remove the locking nut and retaining spring.
3. Place a spool of welding wire over the spindle.

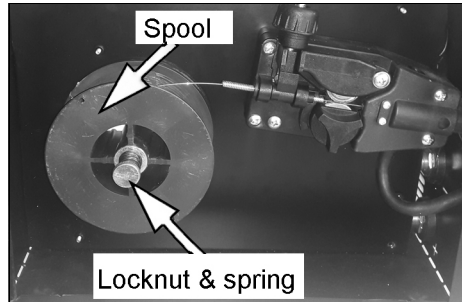

- DO NOT release the tension on the wire, as it will unravel causing feeding problems later.
- The wire will feed off the spool clockwise from the top of the reel.
- The spool must be fitted in the correct orientation otherwise it will not feed correctly.

## SETTING THE DRIVE ROLLER SIZE

1. Loosen the tensioning knob and pivot it towards you.
2. Lift up the arm.
3. Take hold of the triangular knob on the drive roller cover and rotate it 90° anticlockwise to release it.
4. Pull the roller retainer off the drive spindle to reveal the roller.
5. Pull the roller off the drive spindle.

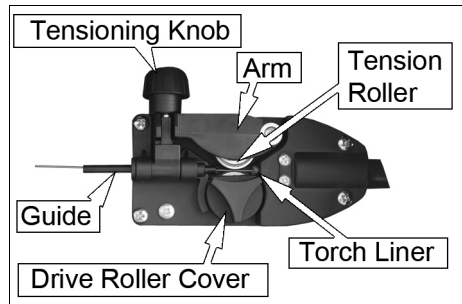

- The groove size is stamped on the corresponding side of the roller. Select the groove size according to the size of the wire you are using and put the roller back on the spindle with your chosen side facing you.

6. Replace the drive roller cover back onto the drive spindle with the opening facing right.
7. Ensure that the flanges at the base of the drive roller cover, seat fully into the circular recess in the main moulding and then rotate the drive roller cover through 90° to lock it in place.

## THREADING THE WIRE

**IMPORTANT: Do not release the tension on the wire as it will unravel causing feeding problems later.**

1. Pull out the end of the wire from the spool, taking care not to release the tension.
  - We recommend you cut off and discard the first 10 cm of wire from the spool to avoid any burrs and then straighten the next few centimetres of wire to help with feeding.
2. Loosen the tensioning knob and pivot it towards you.
3. Lift up the arm.
4. Feed the wire through the guide, over the drive roller and into the torch liner.
  - Push about 10-15 cm into the torch liner.
5. Lower the arm and refit the tensioning knob.
  - Tighten the tensioning knob sufficiently to hold in position, but do not fully tighten.

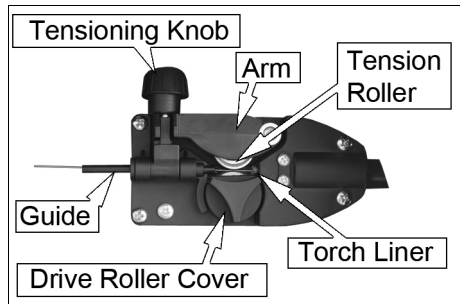

**NOTE:** Correct tension will allow the wire to feed into the torch liner smoothly but will allow the drive roller to slip in the event of a blockage.

6. Close the side panel of the welder.
7. Pull off the torch shroud with a twisting movement, then unscrew the contact tip.
8. Connect the welder to the power supply and switch ON.
9. Set the 'WIRE FEED' rotary control on the front panel to position 7 or 8 and squeeze the trigger on the torch body.
  - The wire will feed through the hose until it appears at the torch tip.
  - Ensuring the hose is free from kinks during this process will assist the wire in its passage through the hose liner.

10. Release the trigger and switch off the welder and disconnect the machine from the mains supply.
11. Refit the appropriate size contact tip (the 0.9 mm tip, for no gas welding is supplied fitted) to suit your wire and replace the shroud.
  - A spare 0.6 and 0.9 mm tip are supplied loose and should be used when using 0.6/0.8 mm mild steel solid wire.
12. Trim the welding wire so that it protrudes no more than 5 mm from the end of the contact tip.

## CONNECTING THE GAS CYLINDER

The welder can be configured to weld, with or without a gas supply according to the type of welding wire being used.

- Mild steel solid core (with gas)
  - Flux cored (no gas)
1. Connect a bottled gas cylinder to the connector at the back of the welder.

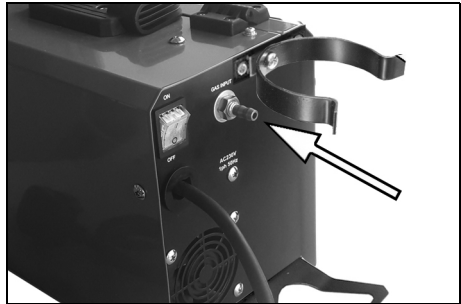

## FITTING THE WELDING ROD

Select the appropriate welding rod and insert it into the welding rod holder.

- It should be approximately the same thickness as the workpieces being welded.

## PREPARING THE WORKPIECE

The area being welded should be perfectly clean. Any coating, plating or corrosion must be removed, otherwise a good weld will be impossible to achieve.

## CONFIGURING THE MACHINE

To prepare the machine for welding it is important that you follow the following procedure.

Attach the earth clamp to the workpiece as close to the point of welding as possible without it being intrusive.

Making sure that the ON/OFF switch, located on the rear panel is in the OFF position, connect the welding leads and gas bottle as follows:

### MIG WELDING WITH GAS

If using 0.9mm flux cored wire, connect the earth clamp to the negative terminal as shown.

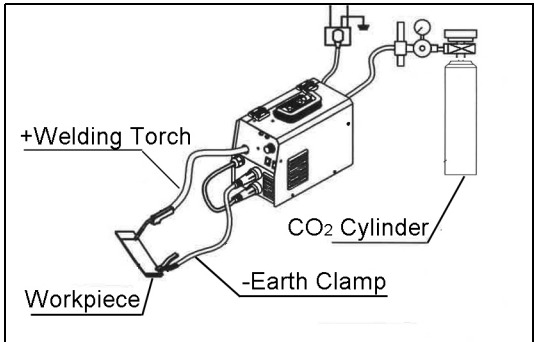

### FLUX WELDING WITH NO GAS

If using 0.9mm flux cored wire, connect the earth clamp to the positive terminal as shown.

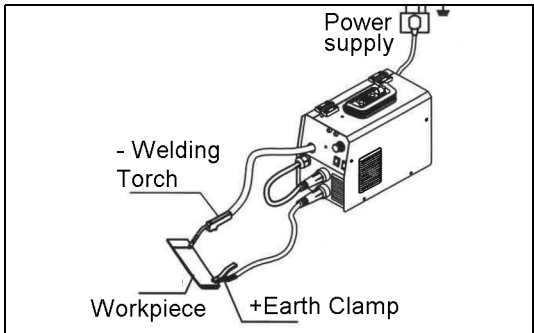

### MMA ELECTRODE WELDING

Connect the earth clamp to the positive terminal and the electrode holder to the negative as shown.

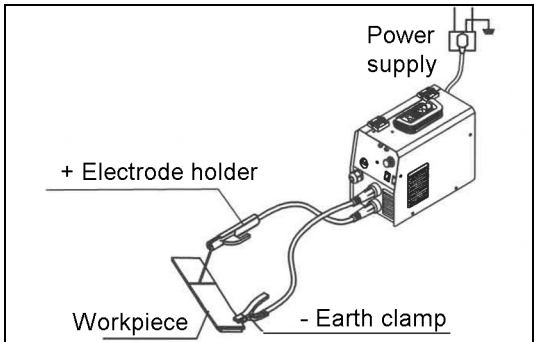

### LIFT-TIG WELDING

Welding rod holder lead to the (+) Positive terminal.

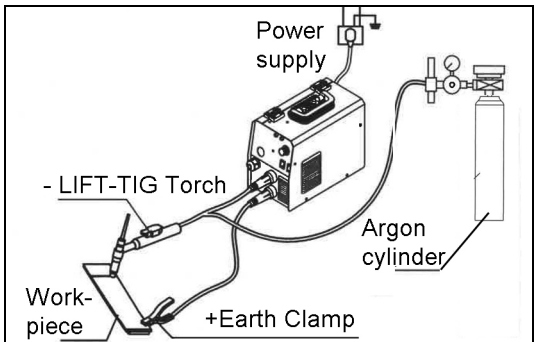

- Switch on using the switch located on the rear panel.

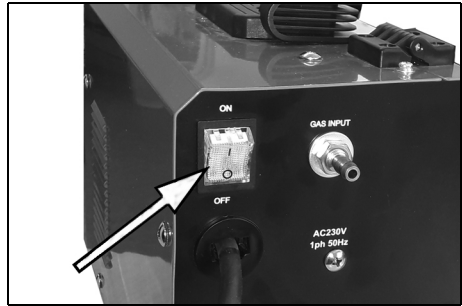

- For Flux or MMA welding, select the appropriate welding rod and fit it into the welding rod holder.



The following sizes can be used and are available from your CLARKE dealer.

	<b>ROD DIAMETER</b>	<b>WORKPIECE THICKNESS</b>
MIG	0.6 mm	1-5 mm
	0.8 mm	
	0.9 mm	
	1.0 mm	
MMA	1.6 mm	1.5 - 2.0 mm
	2.5 mm	2.5 - 3.0 mm
	3.2 mm	3.5 - 4.5 mm

- Attach the work clamp to the workpiece as close as possible to the area being welded. Clean with a wire brush where necessary to ensure the connection is as clean as possible.

## CONTROL SETTINGS

1. Set the rocker switch (1) to either welding mode.
2. Select the welding wire thickness using the left rocker switch (2).
- Set the welding voltage (Settings 1-10) using the selector knob (3).
- With practice you will gain a feel for the correct current setting for different welding rod thicknesses.

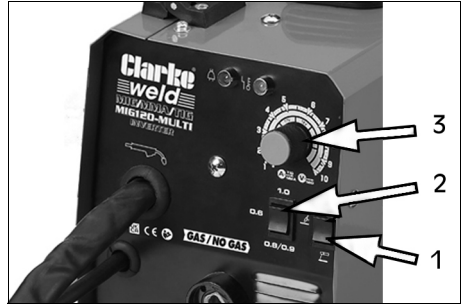

## THERMAL OVERLOAD

The 'Thermal Overload' shuts off the welder when it becomes too hot, due to the duty cycle being exceeded. This is to prevent any damage to the machine.

When this occurs, the warning lamp shown will light up. Allow the welder to cool until the amber light extinguishes before resuming work.



---

## OPERATING THE WELDER (MIG)

---



CAUTION: THE DUTY CYCLE MUST BE ADHERED IN ORDER TO PREVENT THE THERMAL OVERLOAD PROTECTION FROM ACTIVATING

---

1. With the welding current set and the wire trimmed, set the wire feed control to an intermediate setting.
2. Plug the machine into the power supply and switch on.
3. Cover your face with the welding mask supplied.
4. Approach the work with the torch tip at an angle of about 45° and pull the torch trigger fully.
  - As the wire touches the workpiece an arc will be struck.
5. In order to produce a satisfactory weld, the control may be fine tuned as required. This will come with practice.
  - MIG welding is an acquired skill. It is strongly advised that, if you are not fully familiar with this type of welding, you practice on a piece of material with the same characteristics as your workpiece until you are satisfied with the result and you have set your welder to produce a satisfactory weld.
  - One of the problems experienced with novice welders is the welding wire sticking to the contact tip. This is as a result of the wire feed speed being too slow. It is always better therefore to start with too high a speed and back off slightly to avoid the possibility of the wire welding itself to the tip.
  - The speed of wire delivery will increase automatically as the current is increased.
  - Listen to the sound made. An irregular crackling sound denotes too high a wire speed. Decrease the voltage/speed until a regular, strong buzzing sound is heard.

### WELDING TECHNIQUE

- Try to maintain the tip of the nozzle at an angle of approx 45° and at a constant distance of approx 5-7mm from the workpiece.
- Try to maintain a constant speed of movement with the torch.
- **DO NOT** weld in windy conditions or in an area where ventilation is a problem, or where air flow fluctuates.
- **ALWAYS** keep the wire and nozzle clean...NEVER use rusted wire.
- Avoid sharp bends or kinks in the welding hose.

---

## OPERATING THE WELDER (MMA/ARC)

---



**WARNING: WHEN WELDING ALWAYS ENSURE THERE IS ADEQUATE VENTILATION IN THE WORK AREA DUE TO TOXIC FUMES.**

**WARNING: DO NOT STRIKE THE ELECTRODE ON THE WORKPIECE, AS THIS MAY DAMAGE THE ELECTRODE.**

**WARNING: WELDING ARCS PRODUCE HARMFUL UV/IR LIGHT WHICH CAN SERIOUSLY DAMAGE YOUR EYES. ALWAYS USE A WELDING FACE-SHIELD WITH A SUITABLE FILTER THAT CONFORMS TO CURRENT STANDARDS.**

**WARNING: PROTECT BYSTANDERS BY USING WELDING SCREENS.**

---

The consumable electrode is connected to a high amperage low voltage supply which creates an electric arc between the electrode and the workpiece.

The most difficult aspect of the arc welding process, particularly for beginners, is that of striking an arc. We strongly recommend that you practice on some pieces of scrap metal to get the feel of the operation before you start an actual welding job.

1. Holding the welding mask close-up to your face, give a short stroke with the electrode on the workpiece. As soon as the arc is primed, withdraw the electrode from the workpiece to leave a gap. The current will flow across the gap with a crackling noise and a brilliant arc. Continue to weld in one direction, maintaining the small gap as you go.
2. As soon as the arc is struck, maintain a distance from the workpiece equal to the diameter of the electrode. Keep this distance as constant as possible for the duration of the weld. As you advance along the workpiece the angle of the electrode must be maintained at between 20° and 30°.

**NOTE:** When you prime the arc be sure to withdraw the electrode swiftly to leave the gap, otherwise the electrode will weld itself to the workpiece. If this occurs give the electrode a short sharp jerk to free it and, if necessary, prime the arc again. If you cannot free the electrode, switch the machine off immediately and free it. Take care the electrode will get red hot very quickly and will be capable of burning through welding gloves.

3. At the finish of the weld, bring the end of the electrode backward in order to fill the weld crater and then quickly lift the electrode from the weld pool to extinguish the arc.
4. Inspect the job carefully. Any slag forming on the surface should be chipped away with a chipping hammer or pick. ALWAYS wear your safety goggles when chipping away slag.



---

## OPERATING THE WELDER (TIG WELDING)

---

TIG welding is primarily for very thin materials. It uses a non-consumable tungsten (or tungsten alloy) electrode, held in a torch.

A shielding gas (100% Argon), is fed through the torch to protect:

- The electrode
- Molten weld pool
- Solidifying weld metal from contamination by the atmosphere

The electric arc is produced by the passage of current through the conductive, ionized shielding gas. The arc is established between the tip of the electrode and the work. Heat generated by the arc melts the base metal. Once the arc and weld pool are established, the torch is moved along the joint and the arc progressively melts the joined surfaces. Filler wire, if used, is usually added to the leading edge of the weld pool to fill the joint.

This process is ideally suited for welding thin metals such as car body panels, pressure vessels, heat exchangers, pipes etc., where accuracy and a high quality weld is desired, as it produces a very low porosity weld.

### MAIN FEATURES OF TIG WELDING

1. Electronic control of welding current.
2. Forced air cooling.
3. A thermal overload protection device prevents overheating.

### TIG WELDING PROCESS ADVANTAGES

- It produces superior quality welds, generally free of defects.
- It is free of the spatter which occurs with other arc welding processes.
- It can be used with or without filler metal as required.
- It allows excellent control of root pass weld penetration.
- It can produce welds at high speeds.
- It allows precise control of the welding variables.
- It is capable of welding very thin material (0.5mm), without undue distortion.

### LIMITATIONS

1. Greater weld dexterity is required.
2. The DC output is **not suitable** for welding aluminium.

## TIG WELDING

Before TIG welding, you must obtain the correct torch and a gas cylinder of 100% pure Argon. (see page 36)

To prepare the unit for TIG welding, adopt the following procedure.

1. Plug the work clamp lead in to the +ve terminal, and secure the work clamp to the workpiece.
  - For good contact, the work clamp must be attached to clean bare metal. Clean with a wire brush where necessary.

2. Plug the torch lead to the -ve terminal.

3. Screw the pressure regulator on to the gas bottle tightly, and attach the gas hose to the inlet connector securely, with a hose clip.

4. Turn the pressure regulator knob to set a pressure of approx. 2.5kg/cm<sup>2</sup> (35 lbf/in<sup>2</sup>).

5. Ensure the electrode at the torch nozzle, protrudes by 4 - 5mm, also ensure that the electrode is sharply pointed with an angle of 40°- 60° if it is not, grind it to shape.

6. Set the welding current in accordance with the thickness of the material to be welded and the size of tungsten electrode to be used.

7. Switch on using the switch mounted on the rear panel. The green light on the front panel will glow.

8. If the machine stops at any time and the amber light comes on, the thermal overload has intervened. Wait until the welder has cooled sufficiently (the amber light goes out) before restarting work.

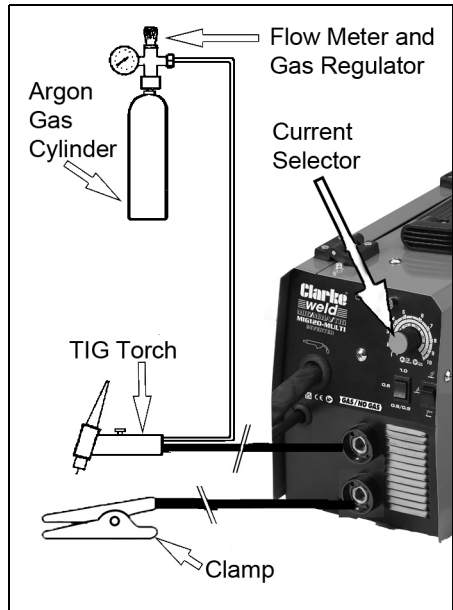

9. Cover your face with the head shield, bring the torch to within 3-4mm of the work, and at an angle of 40-60°, so that the ceramic nozzle gently touches the work surface.

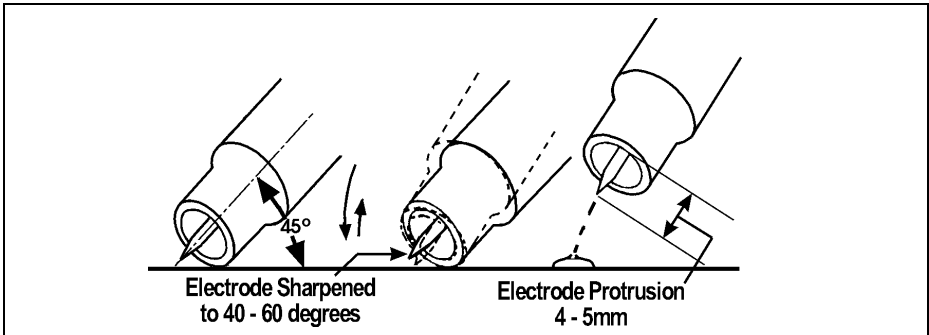

10. Scratch the tip of the electrode against the piece to be welded, as soon as the welding arc starts, remove the electrode to a distance of 3-4 mm, and continue the weld. (See notes below).

- This method is referred to as 'Scratch Arc'.

11. To stop welding, simply remove the torch from the workpiece.

12. Turn off the gas as soon as you finish welding.

Notes:

- To avoid a visible strike mark on the surface of the workpiece it is advisable to strike the arc in the joint where the mark will be concealed by the weld.
- Thin sheet and stainless steel may be welded with or without filler, similar to gas welding.
- The filler is fed in at the edge of the pool. The rod must not touch the tip of the electrode or enter the arc. The end of the rod must always be shielded by the argon atmosphere to prevent as far as possible the formation of oxides of its surface. When welding stainless steel and copper, it is often possible to feed in the filler continuously at the edge of the pool.
- The arc length generally varies between 3 and 6 mm depending on the type of joint, type and thickness of material and so on.
- The torch is advanced in the direction of welding, without lateral movement, maintaining the torch angle of 45° to the workpiece.

# WELDING SETTINGS TABLES

## L-SHAPED BUTT WELDING

Metal thickness (mm)	Wire diameter (mm)	Root gap	Welding current (A)	Welding voltage (V)	Welding speed	Gas Flow (L/min)	Number of
0.8	0.8 - 0.9	0	60-70	16-16.5	50-60	10	1
1.0	0.8 - 0.9	0	75-85	17-17.5	50-60	10-15	1
1.2	0.8 - 0.9	0	80-90	17-18	50-60	10-15	1
1.6	0.8 - 0.9	0	95-105	18-19	45-50	10-15	1
2.0	1.0 - 1.2	0 - 0.5	110-120	19-19.5	45-50	10-15	1
2.3	1.0 - 1.2	0.5 - 1.0	120-130	19.5-20	45-50	10-15	1
3.2	1.0 - 1.2	1.0 - 1.2	140-150	20-21	45-50	10-15	1
4.5	1.0 - 1.2	1.0 - 1.5	140-150	22-23	40-50	15	1
6.0	1.2	1.2 - 1.5	170-185	24-26	40-50	15-20	Positive
9.0	1.2	1.2 - 1.5	320-340	32-34	40-50	15-20	Positive

## ANGLE JOINT (THIN PLATE)

Metal thickness (mm)	Wire diameter (mm)	Welding current (A)	Welding voltage (V)	Welding speed	Distance between conductive nozzle profiles (mm)	Gas Flow (L/min)
1.6	0.8-0.9	65-75	16-17	40-45	10	10-15
2.3	0.8-0.9	80 - 100	19-20	40-45	10	10-15
3.2	1.0-1.2	130 - 150	20-22	35-40	10-15	10-15
4.5	1.0-1.2	150 - 180	21-23	30-35	10-15	10-15

## FLAT FILLET WELDING LAP JOINT (THIN PLATE)

Metal thickness (mm)	Wire diameter (mm)	Welding current (A)	Welding voltage (V)	Welding speed	Distance between conductive nozzle profiles (mm)	Gas Flow (L/min)
0.2	0.8 - 0.9	60-70	16-17	40-45	10	10-15
1.2	0.8 - 0.9	80-90	18-19	45-50	10	10-15
1.6	0.8 - 0.9	90-100	19-20	45-50	10	10-15
2.3	0.8 - 0.9	100-130	100-130	45-50	10	10-15
	1.0-1.2	120-150	120-150	45-50	10	10-15

---

## WELDING PITFALLS

---

The arc welding technique is an acquired skill and requires considerable practice before perfect results are obtained. The diagrams below will help to explain the pitfalls in your technique and how to overcome them.

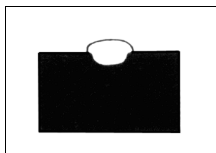

### ARC TOO SHORT

This causes irregular masses of weld to be deposited, with slag contamination on an uneven surface.

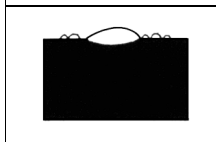

### ARC TOO LONG

This causes poor penetration resulting in a weak weld with excessive spatter and porosity. Surface of the weld is rough and the arc makes a hissing sound

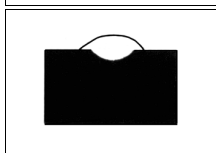

### ELECTRODE MOVED TOO SLOWLY

This causes a very wide and heavy deposit which overlaps at the sides. It is wasteful both in terms of time and electrode use.

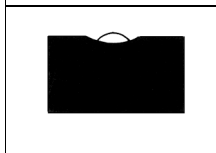

### ELECTRODE MOVED TOO QUICKLY

This causes poor penetration with a 'stringy' and incomplete weld deposit. Slag is very hard to remove.

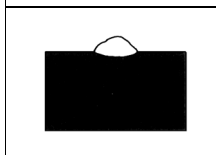

### CURRENT TOO LOW

This causes poor penetration and causes the electrode to stick to the workpiece too readily. Also results in a very irregular and high weld deposit. Slag is very hard to remove.

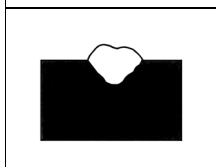

### CURRENT TOO HIGH

This causes excessive penetration with spatter and deep pointed crater. It may also cause holes to be burned in the workpiece.

Burns electrodes very quickly.

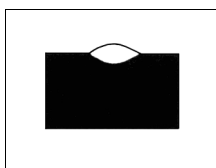

### THE PERFECT WELD

With the correct combination of arc length, current regulation, inclination and speed of the electrode, you will, with practice, produce the perfect weld.

This should be regular with uniform ripples and no slag contamination. The arc will make a steady crackling sound.

## TROUBLESHOOTING

Your CLARKE Welder has been designed to give long and trouble free service. If however, having followed the instructions in this booklet carefully you still encounter problems, the following points should help identify and resolve them.

DEFECT	CAUSES	SUGGESTIONS
Spark will not start	Bad clamp connection. Inverter printed circuit is defective.	Check clamp connection. Contact your nearest CLARKE dealer.
No output voltage	Overheated machine (the amber LED should be on).	Wait for thermal cutout to be reset.
	Internal relay has failed.	Contact your nearest CLARKE dealer.
	Inverter printed circuit is defective.	Contact your nearest CLARKE dealer.
Wrong output current	Current selector control is defective.	Contact your nearest CLARKE dealer.
	Low power supply voltage.	Check the mains distribution system.
Porosity of welds	Acid electrode on steel with high sulphur content. Electrode oscillates too much. Workpieces are too far apart. Workpiece being welded is cold.	Use basic electrode. Move edges to be welded closer together. Move slowly at the beginning.
Cracks in weld	Material being welded is dirty (e.g.oil, paint, rust, oxides). Not enough current.	Clean workpiece before welding is an essential method of achieving neat weld beads. Also increase current output.
Limited penetration	Low current, high welding rate, reversed polarity. Electrode inclined in position opposite to it's movement.	Ensure operating parameters are regulated and improve preparation of work pieces.

<b>DEFECT</b>	<b>CAUSES</b>	<b>SUGGESTIONS</b>
Profile defects	Welding parameters are incorrect. Pass rate is not related to operating parameter requirements. Electrode not inclined constantly while welding.	Follow basic and general welding principles.
High Sprays	Electrode is too inclined.	Make appropriate corrections.
Arc is unstable	Insufficient current.	Check condition of electrode and earth wire connection.
Electrode melts obliquely	Electrode core is not centred. Magnetic blow phenomenon.	Replace electrode. Connect two earth wires to opposite sites of the work piece.
No response from welder.	Check fuses and power lead.	Replace fuses as necessary. If problem persists return welder to your local dealer. Check fuse size.
Welder does not feed wire.	Feed motor defective.	Return welder to your local dealer.
Feed motor running but no wire being fed from welder tip	Insufficient Feed Roller pressure.	Increase roller pressure.
	Burr on end of wire.	Re-cut wire square with no burr.
	Liner blocked or damaged.	Clean with compressed air or replace liner.
	Inferior wire	Use only good "clean" wire.
	Roller worn out.	Replace roller.
Wire welds itself to tip.	Wire feed speed too low.	Unscrew tip, cut wire and fit new tip. Increase wire speed before operating again.
	Wrong size tip.	Fit correct size tip.

<b>DEFECT</b>	<b>CAUSES</b>	<b>SUGGESTIONS</b>
Wire feeds into 'birds nest' tangle.	Wire welded to tip.	As previous plus reduce feed roller pressure.
	Wire liner damaged preventing smooth operation.	Renew wire liner.
Loose coils of wire tangle around wire drum inside machine.	Locking knob too slack.	Tighten Locking Knob slightly. Do not over-tighten.
Erratic wire feed.	Tensioning Knob too tight.	Loosen Tensioning Knob slightly.
	Tension roller worn.	Check and replace if necessary.
	Insufficient pressure on tension roller.	Increase pressure on tension roller Caution: DO NOT over-tighten.
	Wire dirty, rusty, damp or bent.	Re-cut wire and ensure it is clean.
	Liner partially blocked.	Clean with compressed air.
Poor quality welds.	Insufficient gas at weld area.	Check that gas is not being blown away by draughts and if so move to a more sheltered work area. If not, increase gas supply.
	Rusty, painted, damp, oil or greasy workpiece.	Ensure workpiece is clean and dry.
	Rusty/dirty wire.	Ensure wire is clean and dry.
	Poor earth contact.	Check earth clamp/ workpiece connection.
Welder cuts out whilst in use.	Duty cycle exceeded (auto cut-out operates).	Allow welder to cool 15-30 mins before continuing. Note: If duty cycle is continually exceeded, damage to the welder may result and welder output is probably too small for application.



---

## CARE AND MAINTENANCE

---



**WARNING: ELECTRICITY CAN KILL - NEVER TOUCH LIVE ELECTRICAL COMPONENTS.**

**WARNING: DISCONNECT THE POWER SUPPLY BEFORE ALL INSPECTIONS AND MAINTENANCE OPERATIONS. BEWARE HOT SURFACES.**

---

The machine requires no maintenance other than the following guidelines. Cleaning at frequent intervals is advisable if the unit is operating in a very dusty environment.

1. Keep the louvres clean to avoid a build up of dirt and oxides inside the machine which can reduce machine output.
2. Check all cables periodically for condition and secure. They must be in good condition and not cracked.

Always avoid getting particles of metal inside the machine since they could cause short circuits.

Always inspect the earth cable and torch hose before use, to ensure they are in perfect condition and that the earth clamp is clean and secured correctly to the cable.

Check the hose for security and damage.

### **Wire feed unit:**

The feed roller / wire guide plays an important part in achieving consistent results. Check the feed roller groove, removing any deposits.

### **Torch:**

Protect the torch hose assembly from mechanical wear. If the liner is blocked it must be replaced.

### **Contact tip:**

The contact tip is a consumable item and must be replaced when the bore becomes enlarged or oval. The contact tip **MUST** be kept free from spatter to ensure an unimpeded flow of gas.

To keep the contact tip free from spatter, we recommend the use of anti-spatter spray (6000715) available from your CLARKE dealer.

### **Torch shroud:**

The torch shroud must also be kept clean and free from spatter. Build-up of spatter inside the gas cup can cause a short circuit at the contact tip which will result in expensive machine repairs.

# COMPONENT PARTS

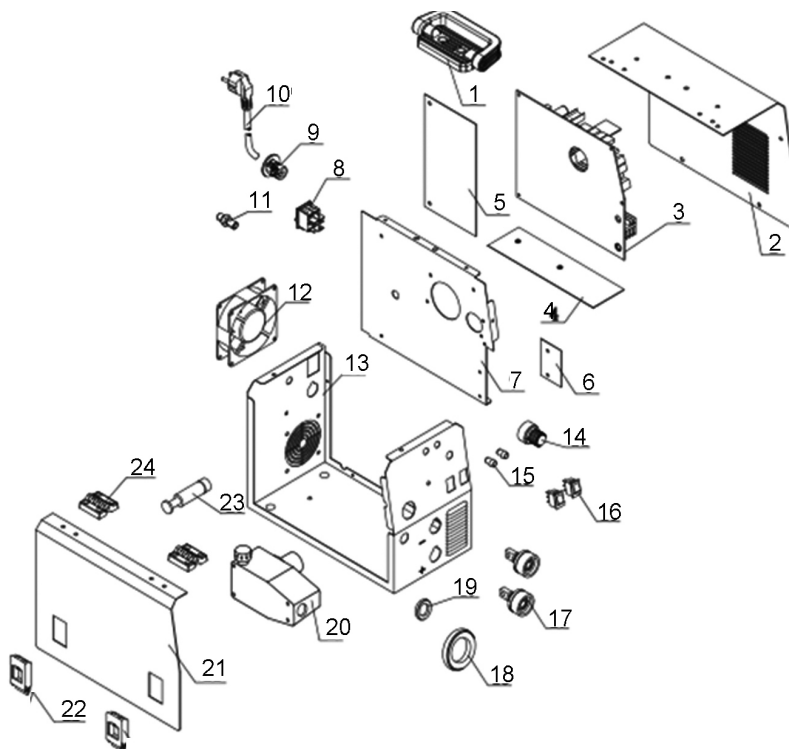

NO	DESCRIPTION	NO	DESCRIPTION
1	Handle	13	Base panel
2	Cover panel	14	Potentiometer
3	Main PCB	15	LED
4	Insulation board 1	16	3-gear switch
5	Insulation board 2	17	Coupling device
6	Dam board	18	Torch cable gland 10 dia
7	Centre panel	19	Torch cable gland 12 dia
8	Power switch	20	Wire feeder
9	Entry port	21	Feeding door
10	Power cable	22	Door lock
11	Gas connector	23	Wire spool
12	Cooling fan	24	Hinge

# THE MACHINE RATING PLATE

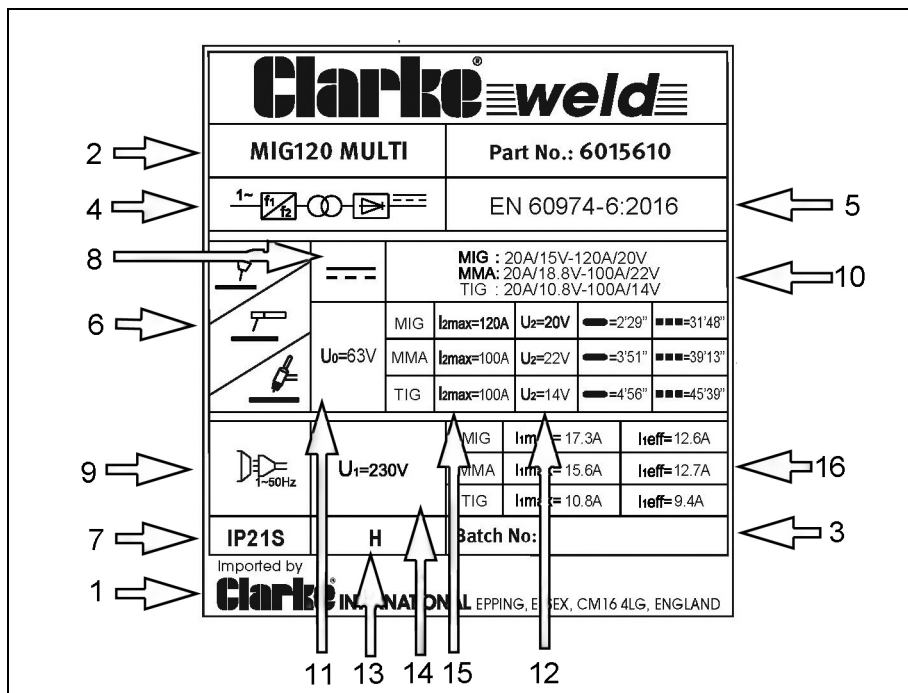

1	Name/address of manufacturer	9	Energy Supply symbol
2	Model Number / Part Number	10	Range of Output
3	Serial / Batch number	11	Rated No-load Voltage
4	Welding Power Source	12	Conventional Load Voltage symbol
5	British Standards applied	13	Insulation grade
6	Welding Process symbol	14	Rated Supply Voltage
7	Degree of Protection	15	Rated Maximum Supply Current
8	Welding Current symbol	16	Maximum Effective Supply Current

This welder is covered by regulations EN 60974-1:2018+A1:2019 / EN 60974-10:2014+A1:2015, where the Duty Cycle is expressed as a percentage of time the machine may be used in a given period for a specified welding current. e.g. When welding at 140 Amps the machine may be used for 6 minutes (60%) in any 10 minute period,

## CONSUMABLES

The following are some of the accessories available from your CLARKE dealer. Please quote the part numbers shown below:

Part	Description	Part number	Comment
Welding Wire Spools	Flux cored mild steel (mini spool) 0.9mm	8132110	Use for no gas welding
	Mild steel (mini) - 0.6mm	8132100	Use for gas welding
	Mild steel (mini) - 0.8mm	8132070	Use for gas welding
	Stainless Steel 0.8mm (mini spool)	8132090	
Welding Gas	CO2 (250g)	6000642	For welding mild steel
	CO2 (600g)	6000643	For welding mild steel
	Argon	6000661	
	CO2/Argon Mix	6000660	For welding stainless/ thin sheet mild steel
Welding Tips	0.6 mm (pack of 5)	8132260	
	0.8 mm (pack of 5)	8132270	
	1.0 mm (pack of 5)	8132275	
Arc Welding Rods	1.6 x 300mm	3050590	
	2.0 x 350mm	3050592	
	2.5 x 350mm	3050594	
	3.25 x 350mm	3050596	
Welding Rods	4.0 x 400mm E6013	3050598	
Welding Torch	Welding Torch Assembly (MMA/TIG)	6012232	
Regulator	Argon Gas Regulator	8134140	

A Gas Regulator, Arc Activated Headshields, Anti-spatter Spray, Swan Necks, Torch Shrouds and Torch Liner are also available from your CLARKE dealer or our parts division.

---

## ARC ACTIVATED HEADSHIELDS

---

These highly popular head-shields activate instantly when the arc is struck and allow you to have both hands free when welding.

Model	Arc Activated	Grinding function	Solar Powered	Fixed Shade	Flip Up	Part Number
GWH2	✓	✓	✓			6000697
GWH3	✓	✓	✓			6000698
GWH4	✓	✓	✓			6000706
GWH5	✓	✓	✓			6000707
GWH6	✓	✓	✓			6000708
GWH7	✓	✓	✓			6000709
PG4	✓	✓	✓			6000716
HS1				✓	✓	6000700
HSF1				✓	✓	6000705

---

## GUARANTEE

---

This CLARKE product is guaranteed against faulty manufacture for a period of 12 months from the date of purchase. Please keep your receipt as proof of purchase.

This guarantee is invalid if the product is found to have been abused or tampered with in any way, or not used for the purpose for which it was intended.

Faulty goods should be returned to their place of purchase, no product can be returned to us without prior permission.

This guarantee does not effect your statutory rights.

# DECLARATION OF CONFORMITY -UK



Hernhall Street, Epping, Essex CM16 4LG

## DECLARATION OF CONFORMITY

**This is an important document and should be retained.**

**We hereby declare that this product(s) complies with the following statutory requirement(s):**

*Electromagnetic Compatibility Regulations 2016*

*Electrical Equipment (Safety) Regulations 2008*

*The Restriction of the Use of Certain Hazardous Substances in Electrical and Electronic Equipment Regulations 2012*

**The following standards have been applied to the product(s):**

*EN 60974-10:2014+A1:2015, EN 60974-1:2012, EN 60974-6:2016, IEC 62321-3-1:2013,*

*IEC 62321-4:2013+A1:2017, IEC 62321-5:2013, IEC 62321-6:2015, IEC 62321-7-1:2015,*

*IEC 62321-7-2:2017, IEC 62321-8:2017*

The technical documentation required to demonstrate that the product(s) meet(s) the requirement(s) of the aforementioned legislation has been compiled and is available for inspection by the relevant enforcement authorities.

The UKCA mark was first applied in: 2022

**Product Description:** 120A MIG/MMA/TIG Inverter Welder  
**Model number(s):** MIG120 MULTI  
**Serial / batch Number:** N/A  
**Date of Issue:** 14/07/2022

**Signed:**

**J.A. Clarke**  
**Director**

# DECLARATION OF CONFORMITY - CE



**Clarke**<sup>®</sup>  
**INTERNATIONAL**

Fitzwilliam Hall, Fitzwilliam Place, Dublin 2

## DECLARATION OF CONFORMITY

**This is an important document and should be retained.**

**We hereby declare that this product(s) complies with the following directive(s):**

2014/30/EU      *Electromagnetic Compatibility Directive*  
2014/35/EU      *Low Voltage Equipment Directive*  
2011/65/EU      *Restriction of the Use of Certain Hazardous Substances in Electrical and Electronic Equipment Directive*

**The following standards have been applied to the product(s):**

*EN 60974-10:2014+A1:2015, EN 60974-1:2012, EN 60974-6:2016, IEC 62321-3-1:2013,  
IEC 62321-4:2013+A1:2017, IEC 62321-5:2013, IEC 62321-6:2015, IEC 62321-7-1:2015,  
IEC 62321-7-2:2017, IEC 62321-8:2017.*

The technical documentation required to demonstrate that the product(s) meet(s) the requirement(s) of the aforementioned directive(s) has been compiled and is available for inspection by the relevant enforcement authorities.

The CE mark was first applied in: 2022

**Product Description:**      120A MIG/MMA/TIG Inverter Welder  
**Model number(s):**      MIG120 MULTI  
**Serial / batch Number:**      N/A  
**Date of issue:**      14/07/2022

**Signed:**

.....  
**J.A. Clarke**  
**Director**

# A SELECTION FROM THE VAST RANGE OF

# Clarke®

## QUALITY PRODUCTS



**AIR COMPRESSORS**  
From DIY to industrial, Plus air tools, spray guns and accessories.

**GENERATORS**  
Prime duty or emergency standby for business, home and leisure.

**POWER WASHERS**  
Hot and cold, electric and engine driven - we have what you need

**WELDERS**  
Mig, Arc, Tig and Spot. From DIY to auto/industrial.

**METALWORKING**  
Drills, grinders and saws for DIY and professional use.

**WOODWORKING**  
Saws, sanders, lathes, mortisers and dust extraction.

**HYDRAULICS**  
Cranes, body repair kits, transmission jacks for all types of workshop use.

**WATER PUMPS**  
Submersible, electric and engine driven for DIY, agriculture and industry.

**POWERTOOLS**  
Angle grinders, cordless drill sets, saws and sanders.

**STARTERS/CHARGERS**  
All sizes for car and commercial use.



## PARTS & SERVICE: 0208 988 7400

**Parts Enquiries**  
[Parts@clarkeinternational.com](mailto:Parts@clarkeinternational.com)

**Servicing & Technical Enquiries**  
[Service@clarkeinternational.com](mailto:Service@clarkeinternational.com)

SALES: UK 01992 565333 or Export 00 44 (0)1992 565335

**Clarke®** INTERNATIONAL Hemnall Street, Epping, Essex CM16 4LG  
[www.clarkeinternational.com](http://www.clarkeinternational.com)